

# Industrial Engineering Guide

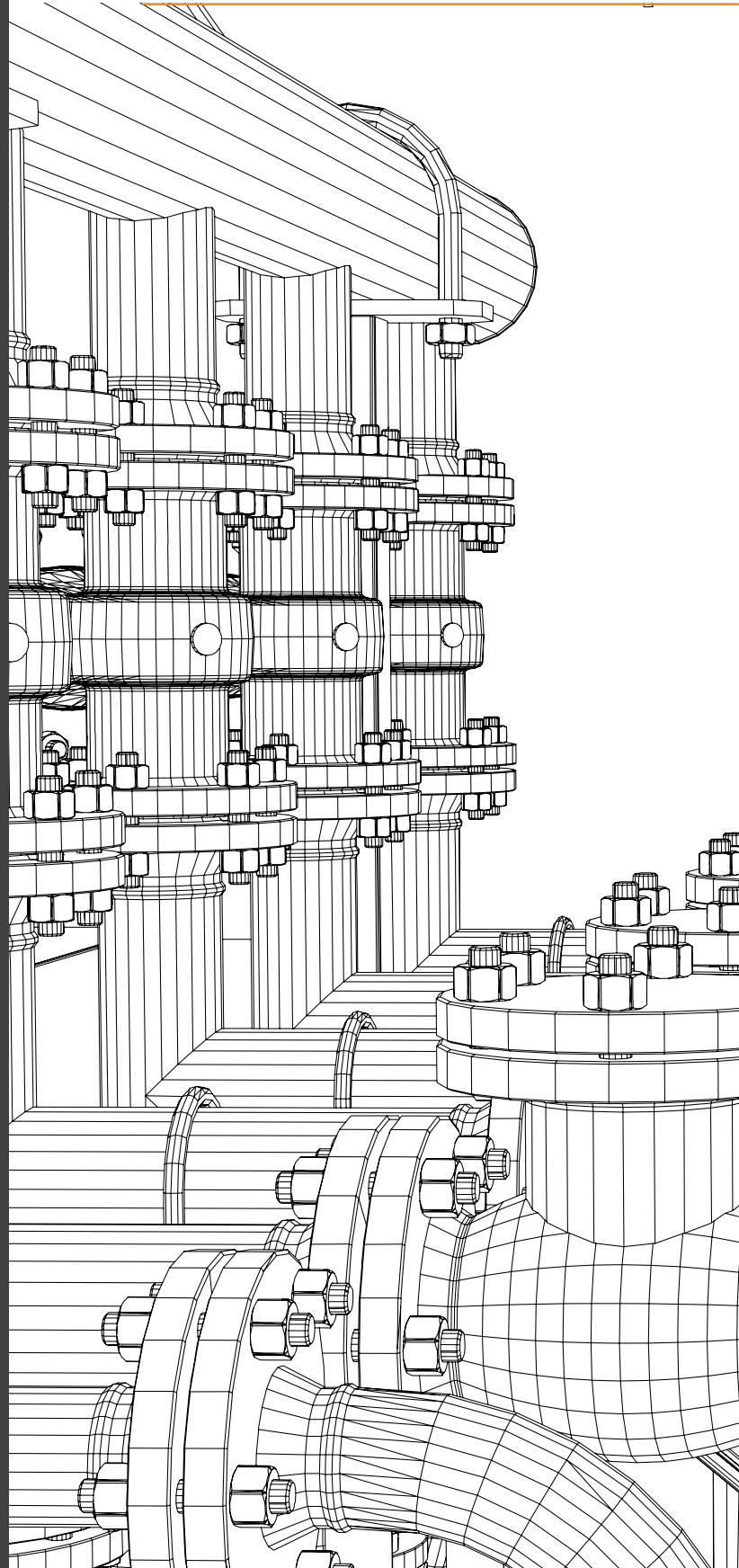

For industrial piping systems



**Golan Plastic Products**, manufacturer and distributor of Pexgol, is a world leader in providing comprehensive solutions for the transportation of all types of hot, corrosive, or abrasive liquid materials. We are the only manufacturer on an international scale with factories in Israel, Argentina, Chile and Mexico specializing in large diameter, cross-linked polyethylene pipe systems, the most cost-effective, long-term solutions available to infrastructure, industrial, oil & gas and mining sectors throughout the world.

Established in 1964, **Golan Plastic Products** today is a global company listed on the Tel Aviv stock exchange.

**Pexgol's** global reputation and reliable brand name are based on accredited international standards in more than 40 countries, along with a decades-long proven track record with established clients around the world.

# Pexgol Solutions for Industrial Applications

2023

[www.pexgol.com](http://www.pexgol.com)

## Abstract

Pexgol pipes, with their excellent resistance to temperature extremes, chemicals and abrasion are ideal conduits for a wide range of industrial applications.

Pexgol pipes offer a successful, cost-effective solution where conventional pipes would be unsatisfactory for conveying slurries due to their poor abrasion resistance or because of vulnerability to chemicals.

Industrial applications of Pexgol pipes include transporting slurries, gypsum, sand, salt, phosphates, silts, potash, and various chemicals and industrial wastes.

© Copyright Pexgol

**pexgol**  
X-LINKED PIPING SOLUTIONS

# Index

## / 1

### The Principles of System Design

Defining the design temperature.....	8
Water & Newtonian Fluids.....	9
Replacing Waterline Steel Pipes.....	10
Influence of Temperature Changes on Pexgol Pipes .....	10
Pexgol Pipes Above Ground.....	11
Pipes under Full Vacuum Conditions .....	11
Pexgol Pipes at Low Temperatures .....	12
Slurry Design Considerations.....	13
Field Weld .....	14
Water Hammer .....	15
Air Relief Valves .....	15

## / 2

### Pexgol System

Pexgol System .....	18
Industrial Recommendations .....	19
Fittings Catalogue.....	20

## / 3

### Valves

Butterfly Valve.....	31
----------------------	----

/ 4

## Gaskets

Gaskets.....34

/ 5

## Above Ground Installations

Above Ground Installations.....38  
Calculation of Forces at Fixpoints  
.....40  
Pexgol Horizontally Supported Pipe-  
line .....43  
Natural Bending Radius.....44

/ 6

## Installation

Installation Instructions for Coils  
.....48  
Delivery, Storage & Handling .....49





# The Principles of System Design

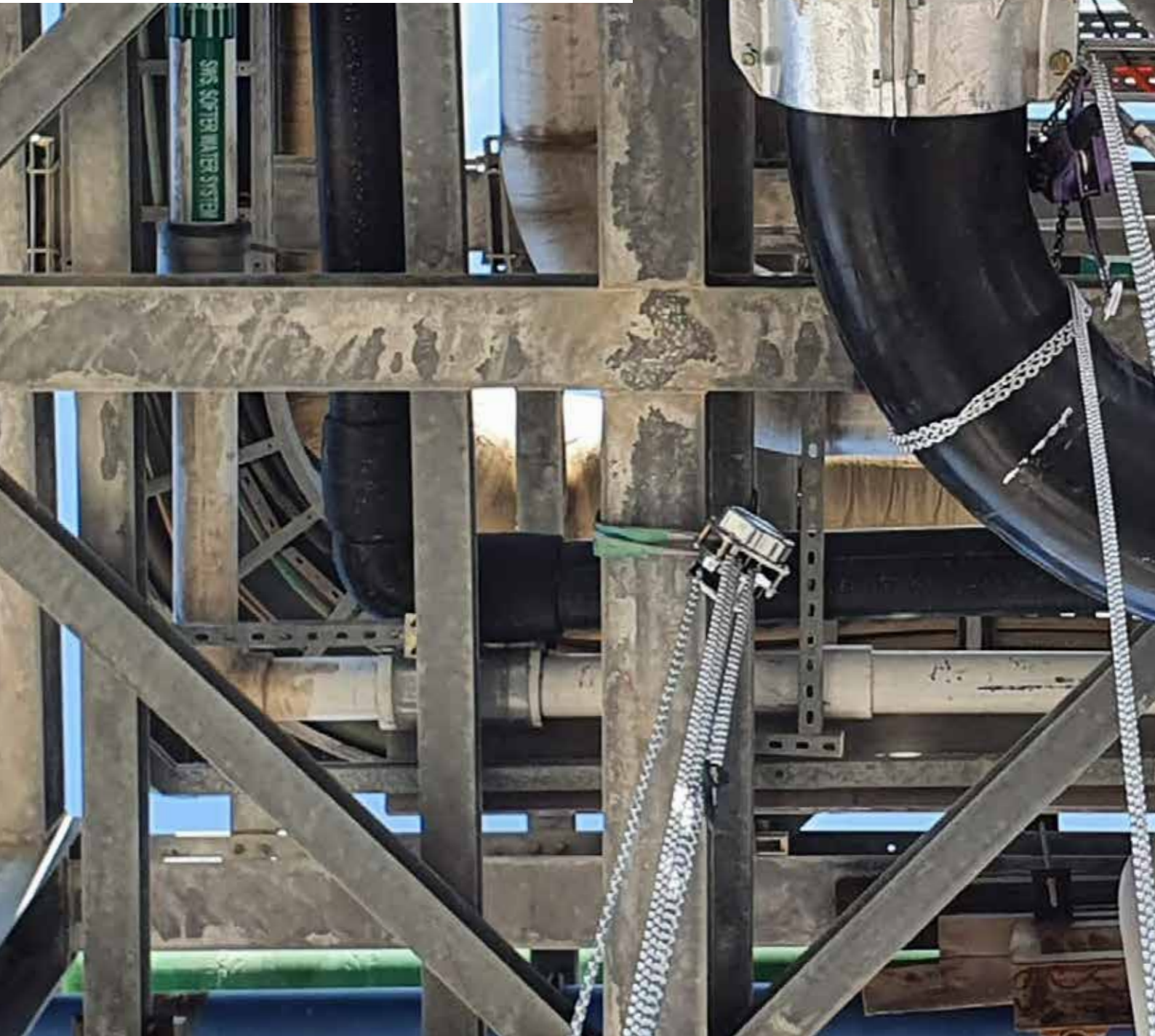



## Index

---

Defining the design temperature

Water & Newtonian Fluids

Replacing Waterline Steel Pipes

Influence of Temperature Changes  
on Pexgol Pipes

Pexgol Pipes Above Ground

Pipes under Full Vacuum Conditions

Pexgol Pipes at Low Temperatures

Slurry Design Considerations

Field Weld

Water Hammer

Air Relief Valves

# Defining the design temperature

1. The design temperature of the Pexgol pipe is calculated based on the data from the RFI questionnaire.
2. For insulated / buried pipes, the design temperature is equal to the fluid temperature.
3. In case of above-ground installation, the design temperature of the Pexgol pipe is to be calculated as the mean value between the Tex(Temperature of the external pipe surface) and Tfl (Fluid temperature).
  - 3.1 The temperature of the external pipe surface is calculated as 20°C above the ambient temperature:

$$T_{ex} = T_{amb.} + 20^{\circ}\text{C}.$$

To facilitate the calculation, we have included the following table.

4. Example:

*Fluid temperature 20°C, ambient temperature 40°C*

$$T_{ex} = 40 + 20 = 60^{\circ}\text{C}$$

$$\text{Design temperature } \frac{60 + 20}{2} = 40^{\circ}\text{C}$$

**Table 8.1: Defining design temperature**

Fluid Temperature °C	Surface Temperature (TEX)					
	20	30	40	50	60	70
	Design Temperature					
20	20	25	30	35	40	45
30	25	30	35	40	45	50
40	30	35	40	45	50	55
50	35	40	45	50	55	60
60	40	45	50	55	60	65



# Water & Newtonian Fluids

The pipe SDR is selected according to the following data from the RFI questionnaire:

1. Pressure head losses in the line expressed in bars (considering the specific gravity of the transported material).
2. Design temperature (see first paragraph above).

**Basic safety factor (design coefficient):**

For Pexgol chemical resistance, see the "Chemical Resistance" chapter in the Engineering Guide.

- 1.25 for water and fluids with the classification A in the chemical resistance list.
- 1.5 for air supply lines.

Static pressure according to the altitude difference in the line and the specific gravity of the transported material. If the pipeline is horizontal and the static pressure is low, select SDR 17 and verify its suitability.

Choose a lower SDR with the same OD to increase the transportable section lengths.

The hydraulic calculation usually results in the same OD. If the altitude difference in the line is significant, select a Pexgol pipe SDR that has in the design temperature higher pressure rating than the static pressure. The additional pressure margin is used for the pressure head losses; this will determine the ID of the pipe.

The OD is determined by the Pexgol pipe SDR the customer chooses and the availability of this specific pipe diameter.

# Replacing Waterline Steel Pipes

When replacing steel pipes (Hazen - Williams C = 110) with Pexgol pipes (Hazen - Williams C = 155) with the same pressure head losses, the ID (inside diameter) of the Pexgol pipe can be 88% of the ID of the existing steel pipe. When replacing steel pipes with Pexgol pipes with the same ID, the head losses are expected to be lower by 50%.

# Influence of Temperature Changes on Pexgol Pipes

Pexgol pipes placed above the ground or over bridges tend to get longer (to expand) when temperature rises (snaking phenomenon) or to get shorter (contract) as the temperature decreases. Expansion or contraction does not affect the Pexgol pipe, even in extremely low temperatures. There is no need to protect the pipe against thermal stresses, as they are absorbed by the pipe.

Fixpoints or guiding clamps are used for restraining the elongation of the pipe (mainly for aesthetic considerations). There is no need for installation of "expansion joints" or omegas to protect the Pexgol pipe.

In some cases, special fixpoint clamps should be used before and after the fittings (as recommended) to prevent the pipe from pulling out. These cases are specified in page 60 - 62.



# Pexgol Pipes Above Ground

Pexgol pipes withstand exposure to sunlight for unlimited periods—that is, the lifetime of the pipe.

- Pexgol pipes can be placed directly on ground.
- Special bedding is not required.

For more information please see page 76 in the Engineering guide.

# Pipes under Full Vacuum Conditions

It is recommended to use a minimum pipe SDR 11. For more information please see page 51 “Vacuum/Suction Pipelines” at the Engineering Guide.



# Pexgol Pipes at Low Temperatures

Pexgol pipes are used at temperatures of -50°C and even lower. Since the Pexgol material does not become fragile at these temperatures, it tolerates bending and dragging at low temperatures during installation. Pexgol pipes tolerate complete “homogeneous” freezing of the transported liquid. Homogeneous freezing takes place if the pipe is evenly exposed to low temperatures along the pipeline.

However, if freezing starts at localized freezing points, the pressure of the fluid which is trapped between two adjacent freezing points increases until the pipe bursts. This happens to any pipe material. Localized freezing points might be metal fittings (including PE-X lined steel fittings), fixpoint clamps or any point where the metal touches the pipe. Consequently, localized freezing points should be avoided or properly insulated.

Please note that this applies to both above ground and shallow underground installations.

# Slurry Design Considerations

1. The choice of pipe class is determined based on the following data from the RFI Application Questionnaire:
  - Working pressure
  - Design temperature
  - Chemical resistance of the pipe material to the slurry
2. The pipe diameter is chosen based on the ID of existing steel pipe or on the value of the minimum critical slurry velocity.
3. **Replacing carbon steel slurry pipes with Pexgol pipes with the same ID:** A slurry pipeline is designed according to the minimum critical velocity of the slurry material. Carbon steel slurry pipes can be replaced with Pexgol pipes of the same or slightly smaller nominal ID, maintaining the same slurry velocity.
4. Pexgol pipes have an "abrasion allowance" of 20% of the nominal wall thickness of the pipe. This means that the pipe can withstand the design working pressure until the remaining wall thickness of the pipe is reduced to 80% of the nominal value. The real lifetime of the pipe depends on the actual abrasion rate in the line. The 80% rule applies for all working pressures and all temperatures in all classes.
5. Increasing the ID of the Pexgol pipes due to abrasion results in decreasing the velocity of the slurry. Make sure that the value of the minimum critical slurry velocity is maintained after 20% abrasion.



# Field Weld

Field welds should be included to help compensate for the deviation of the actual pipe length from the design. Also, the actual length of the pipe can differ from the design length due to production tolerances and temperature changes.

When using mechanical connectors or EF couplers, it is recommended to add extra sections and connections to the final design for field adjustments – “field weld”.

In addition, it is important to cut the pipe straight. For diameters up to 160 mm class 15 we recommend using a rotational pipe cutter.

For all classes up to diameters 315 we recommend using a jigsaw blade machine.

For diameters above 315 in all pipe classes we recommend using a rotary saw machine.

For more information, please check our “Pexgol EF recommended equipment guide”.



# Water Hammer

Because of the flexibility and resilience of Pexgol pipes, in comparison to other pipes, surge pressures derived from water hammer are greatly reduced. Furthermore, because of the cross-linked structure, the Pexgol pipe can withstand a total transient pressure (recurring or occasional surge pressure + working pressure) at least 2.5 times the design pressure in the relevant temperature.

For further information and calculations, please see page 44 at the Engineering Guide Chapter 1: "Technical Information".

# Air Relief Valves

Air relief valves are required in any pipeline material, including Pexgol. The line designer should specify all the required accessories including air relief valves and drain valves.

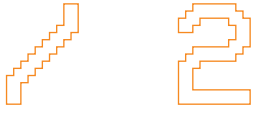

# Pexgol System







## Index

---

Pexgol System

Industrial Recommendations

Fittings Catalogue

# Pexgol System

Pexgol provides full temperature range solution (pipe and fitting) from -50°C to 110°C.

The following table shows which accessories can be used on Pexgol systems depending on the design conditions, pressure, and temperature.

**Table 18.1: Fitting Capabilities (according to groups)**

	Pressure	Temperature rating	Material
<b>Pexgol pipes and fittings</b>	Class 10/12/15/19/24/30	-50°C/-58°F to 110°C/230°F	Cross Linked Polyethylene [Pe-Xa]
<b>Electrofusion fittings</b>	P.N 16/ 25	-30°C/-22°F to 50°C/122°F	PE100
<b>Reinforced Electrofusion Couplers</b>	Compatible with all Pexgol pipes in class 30 (SDR 6) *For series 2 at high pressure please consult Pexgol team	Series 1: -30°C/-22°F to 70°C/158°F Series 2: 30°C/-22°F to 90°C/194°F	Series 1: 63~140: PE100 + Stainless Steel Reinforcement 160~630: PE100+ Fiber Reinforcement Series 2: PE-RT+ Stainless Steel Reinforcement
<b>PE-Xc fittings</b>	Compatible with Pexgol pipe class 15 (SDR11)	-30°C/-58°F to 90°C/194°F	PE-Xc
<b>CS PE-X lined fittings</b>	Maximum Pressure according to the pipe class.	-30°C/-22°F to 90°C/194°F	CS, SS 304/316, PEX lining
<b>CS Teflon lined fittings</b>	Maximum Pressure according to the pipe class.	-30°C/-22°F to 110°C/230°F	CS, SS 304/316, Teflon lining
<b>Brass fittings</b>	Class 15/24	Maximum Temperature according to the pipe class.	Brass fittings
<b>GP Bolt Connector SS</b>	Class 15/24	Maximum Temperature according to the pipe class. Size range according to catalogue.	316 L
<b>PE100 fittings</b>	P.N 16	-30°C/-58°F to 50°C/122°F	PE100

2023

Pexgol System





# Industrial Recommendations

**Table 19.1: General compatibility guidelines for industrial applications**

Properties	Pexgol (PE-Xa)	CS PE-X Lined	CS Teflon Lined	PE-Xc (radiation)
<b>Temperature capabilities</b>	<110°C (230°F)	< 90°C (195°F)	<110°C (230°F)	<90°C (195°F)
<b>Pressure</b>	All classes	All classes	All classes	Up to class 15
<b>Abrasion resistance</b>	Excellent	Good	Good	Good
<b>Corrosion resistance</b>	Excellent	Medium	Good	Good
<b>Scaling resistance</b>	Excellent	Good	Good	Medium

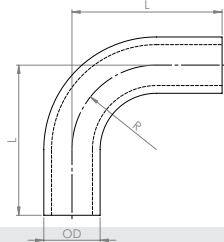
# Fittings Catalogue

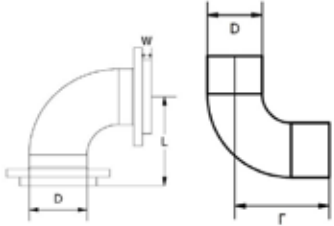
**Table 20.1: Elbows**

	Diameter	Radius	Remarks	
<b>Pexgol</b>	Up to 710mmØ	1.5D/3D	<ul style="list-style-type: none"> <li>The elbows are supplied with clamps and fixing elements for an accurate angle.</li> <li>After installation it is possible to remove the clamps if required.</li> <li>Manufactured from class 15.</li> </ul>	
<b>CS Lined</b>	2" up to 24" For smaller diameters please consult Pexgol team	1D/1.5D	<ul style="list-style-type: none"> <li>Lining PE-X / Teflon</li> <li>One or two loose flanges.</li> <li>Flanges ANSI 150.</li> </ul>	
<b>Electrofusion fittings</b>	200 - 2500	1D	<ul style="list-style-type: none"> <li>PN 16</li> </ul>	
<b>PE-Xc fittings</b>	630 - 5000 For larger diameters please consult Pexgol team	63 - 400: 1D For 450 and above: 1.5D	<ul style="list-style-type: none"> <li>Class 15</li> <li>Plain ends - Connections suitable for Electrofusion couplers or GP Flange couplers up to Ø630.</li> <li>Stub ends - Can be supplied with flanges ASA150 up to Ø500.</li> <li>**Different flange standards are supplied on special request.</li> </ul>	
<b>PE100 fittings</b>	2000 - 4000 For different diameters please consult Pexgol team	1D	<ul style="list-style-type: none"> <li>SDR 11/17</li> <li>Plain ends (spigot)</li> </ul>	



2023

Pexgol System

**Table 21.1: Tees**

	Item	Diameter	Remarks	
<b>Electrofusion fittings</b>	Equal Tee (90°) Flanged Tee / spigot.	20Ø up to 250Ø	<ul style="list-style-type: none"> <li>Standard length</li> <li>PN16</li> </ul>	
	Reducing Tee	25Ø up to 250Ø		
<b>CS Lined fittings</b>	Equal Tee (90°)	2" up to 24"	<ul style="list-style-type: none"> <li>Lining PE-X / Teflon</li> <li>One or two loose flanges.</li> <li>ANSI B16.5 Class 150 flanges.</li> <li>Longer lengths are available upon special request</li> </ul>	
	Reducing Tee			
	Equal Cross			
	Lateral Tee			
<b>PE-Xc fittings</b>	Equal Tee (90°)	up to 500Ø	<ul style="list-style-type: none"> <li>Longer lengths are available upon special request</li> </ul>	
	Reducing Tee			
	Lateral Tee			
<b>PE100</b>	Equal Tee (90°)	up to 500Ø	<ul style="list-style-type: none"> <li>Longer lengths are available upon special request</li> <li>Plain ends</li> </ul>	
	Lateral Tee	up to 315Ø	<ul style="list-style-type: none"> <li>SDR 11</li> </ul>	

**Table 22.1: Saddles**

	Diameter	Remarks	
<b>Branch-off Saddle</b>	110 -630	<ul style="list-style-type: none"> <li>Type 304 stainless steel</li> <li>Pressure rating: Up to 12 bar</li> <li>Temperature rating: -30°C/-22°F to 85°C/185°F</li> <li>Male / Female Thread Outlet</li> </ul>	
<b>Electrofusion fittings</b>	63 -710	<ul style="list-style-type: none"> <li>PN 16/10</li> </ul>	

**Table 22.2: Instrument Tee**

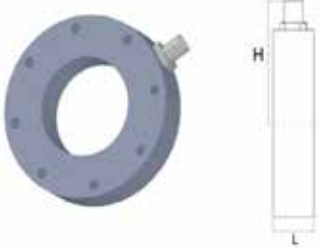
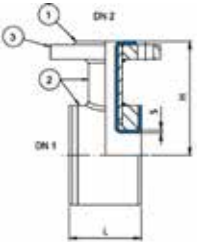
	Diameter	Remarks	
<b>PE-Xc fittings</b>	2" (63) up to 28"(710)	<ul style="list-style-type: none"> <li>Different spacer lengths available upon request.</li> <li>We recommend the usage of gaskets when using this accessory.</li> <li>Bolt circle diameter and bolt holes: according to ANSI150.</li> <li>Flanged outlet upon special request.</li> <li>Different outlet dimensions (size/standard) up to 1-1/2" upon request.</li> <li>Inside diameter according to project requirement or customer specifications.</li> </ul>	
<b>CS lined</b>	2" up to 24"	<ul style="list-style-type: none"> <li>Lining PE-X / Teflon</li> <li>ANSI B16.5 Class 150 flanges</li> </ul>	





**Table 23.1: Reducers**

	Diameter	Remarks	
<b>Pexgol Reducer</b>	1" (32 mm) up to 24"(630 mm)	<ul style="list-style-type: none"> <li>Concentric reducers</li> <li>The working pressures and temperatures of the Pexgol reducers are the same as for the d1 side of the reducer.</li> </ul>	
<b>Pex-c Prefabricated Reducer</b>	90 up to 500 mm For other diameters please consult Pexgol team	<ul style="list-style-type: none"> <li>SDR 11</li> <li>Plain ends / flanged</li> <li>Concentric / Eccentric</li> </ul>	
<b>CS Lined reducer</b>	2" up to 24"	<ul style="list-style-type: none"> <li>Lining PE-X / Teflon</li> <li>One or two loose flanges</li> <li>ANSI B16.5 Class 150 flanges</li> <li>Concentric / Eccentric</li> </ul>	
<b>Electrofusion fittings</b>	20 up to 180 mm	<ul style="list-style-type: none"> <li>PN 16</li> <li>Concentric reducers</li> </ul>	
<b>PE 100- Prefabricated Reducer</b>	2" (63 mm) up to 24"(630 mm)	<ul style="list-style-type: none"> <li>SDR 11</li> <li>Plain ends / flanged</li> <li>Concentric reducer</li> </ul>	



Table 24.1: Pipes connections

	Diameter	Remarks				
<b>G.P Coupler</b>	2" (63 mm) up to 28"(710 mm)	<ul style="list-style-type: none"> <li>Diameters 63 mm -280 mm are suitable for the full pipe pressure and temperature range.</li> <li>Diameters 315 mm - 450 mm consider maximum pressure of 19 bar.</li> <li>Diameters 500 mm - 710 mm consider maximum pressure of 10 bar</li> <li>Standard Gasket: EPDM rubber</li> </ul>				
<b>Mechanical Double Connector</b>	63 - 315 mm	<ul style="list-style-type: none"> <li>Suitable for all pressures and temperatures from Class 10 to 24.</li> <li>Standard Gasket: EPDM rubber</li> </ul>				
<b>Flared ends (PE-Xa)</b>	32 - 500 mm	<ul style="list-style-type: none"> <li>Manufacture from class 10 to 15. For higher classes consult GOLAN.</li> <li>ASA150/BSTD Flanges.</li> <li>Others flange standards are available by special order.</li> </ul>				
<b>Electrofusion fittings</b>	PN 16: 16 - 710 mm PN 25: 50 - 355 mm	<ul style="list-style-type: none"> <li>Temperature rating: -10°C/-14°F to 50°C/122°F</li> </ul>				
			Temperature C°	Pressure PN 16		Pressure PN 25
			20	16		25.0
			25	15		23.5
			30	13.9		21.8
			35	13		20.3
			40	11.8		18.5
	45	10.9	17.0			
	50	Consult GPP				
<b>Reinforced Electrofusion Coupler Series 1</b>	63 - 630 mm	<ul style="list-style-type: none"> <li>Body Material 63 Ø -140 Ø: PE100+ Stainless Steel Reinforcement</li> <li>Body Material 160 Ø -630 Ø: PE100+ Fiber Reinforcement</li> <li>Temperature rating: -30°C/-22°F to 70°C/158°F</li> </ul>				
			Temperature C°/F°	Bar/Psi		
			10°/50°	34/493		
			20°/68°	30/435		
			30°/86°	26.6/385		
			40°/104°	23.56/341		
			50°/122°	21/304		
			60°/140°	19/275		
	70°/158°	16.88/244				







	Diameter	Remarks			
<b>Reinforced Electrofusion Coupler Series 2</b>	63 - 160 mm	<ul style="list-style-type: none"> <li>Body Material PE-RT+ Stainless Steel Reinforcement</li> <li>For Temp above 70° requires the addition fixpoint bridge.</li> </ul>		Temperature C°/F°	
		Bar/Psi			
		10°/50°		34/493	
		20°/68°		30/435	
		30°/86°		26.6/385	
		40°/104°		23.56/341	
		50°/122°		21/304	
		60°/140°		19/275	
		70°/158°		16.88/244	
80°/176°		15.12/219			
90°/194°		13/188			
<b>SS GP bolt connector</b>	63 – 225 mm	<ul style="list-style-type: none"> <li>Body Material: Stainless Steel 316 L</li> <li>Fitting available for Pexgol pipes class 15 &amp; 24</li> <li>Provided with NPT thread. BSPT thread upon request.</li> <li>Bolts are included</li> </ul>			
<b>Victaulic Couplings for PE-Xa Pipe 905</b>	63 – 355 mm	<ul style="list-style-type: none"> <li>Operating Temperature Range: -20°F to +230°F/-29°C to +110°C.</li> <li>Maximum Working Pressure Couplings are rated to the pressure rating of the Pexgol pipe on which they are installed.</li> <li>Available gaskets: Nitrile, EPDM, Fluoroelastomer.</li> <li>Housing: Ductile iron</li> <li>Retaining Ring: Type 316 stainless steel.</li> <li>For use on plain end</li> </ul>			
<b>Victaulic Couplings for PE-Xa Pipe 907</b>	63 – 355 mm (To 2 – 14”/DN50 – DN350 mm grooved steel)	<ul style="list-style-type: none"> <li>Operating Temperature Range: -20°F to +230°F/-29°C to +110°C.</li> <li>Maximum Working Pressure Couplings are rated to the pressure rating of the Pexgol pipe on which they are installed.</li> <li>Available gaskets: Nitrile, EPDM, Fluoroelastomer.</li> <li>Housing: Ductile iron</li> <li>Retaining Ring: Type 316 stainless steel.</li> <li>Transition Coupling for Pexgol to grooved Steel Pipe.</li> </ul>			
<b>Victaulic Couplings for PE-Xa Pipe 908</b>	400 - 710 mm	<ul style="list-style-type: none"> <li>Operating Temperature Range: -20°F to +230°F/-29°C to +110°C.</li> <li>Maximum Working Pressure Couplings are rated to the pressure rating of the Pexgol pipe on which they are installed.</li> <li>Available gaskets: Nitrile, EPDM, Fluoroelastomer.</li> <li>Housing: Ductile iron</li> <li>Coupling for Double Grooved Pexgol Pipe Style 908.</li> <li>Look for “Cut Groove Specifications”.</li> </ul>			

**Table 26.1: Repair Fittings**

	Diameter	Remarks	
<b>Repair Mechanical Fitting</b>	110 - 630 mm	<ul style="list-style-type: none"> <li>Type 304 stainless steel</li> <li>Pressure rating: Up to 12 bar</li> </ul>	
<b>Electrofusion fittings</b>	63 -180 mm	<ul style="list-style-type: none"> <li>Temperature rating: -10°C/-14°F to 50°C/122°F</li> <li>PN 16</li> </ul>	

**Table 26.2: Brass Fittings**

	Diameter	Remarks	
<b>Branch-off saddles – Male/ female Thread</b>	63 -160 mm	<ul style="list-style-type: none"> <li>Male BSPT thread</li> <li>Female thread BS</li> </ul>	
<b>Gp Bolt connectors Male/ female Thread</b>	63 -160 mm	<ul style="list-style-type: none"> <li>Male BSPT thread</li> </ul>	
<b>PE-X Double Bolt Connectors</b>	63 -160 mm	<ul style="list-style-type: none"> <li>Class 15/24</li> </ul>	

	Diameter	Remarks	
<b>PE-X Double Bolt Connectors with slide outlet</b>	40 -63 mm	<ul style="list-style-type: none"> <li>• Class 24</li> <li>• Female thread BSPT</li> </ul>	

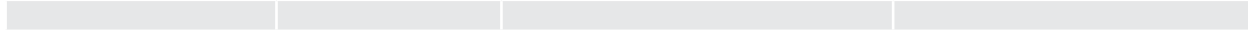

<b>PE-X Reducing Connectors with Side Outlet</b>	25 -50 mm	<ul style="list-style-type: none"> <li>• Class 24</li> <li>• Female thread BSPT</li> </ul>	
--	-----------	--	---

1 3

# Valves

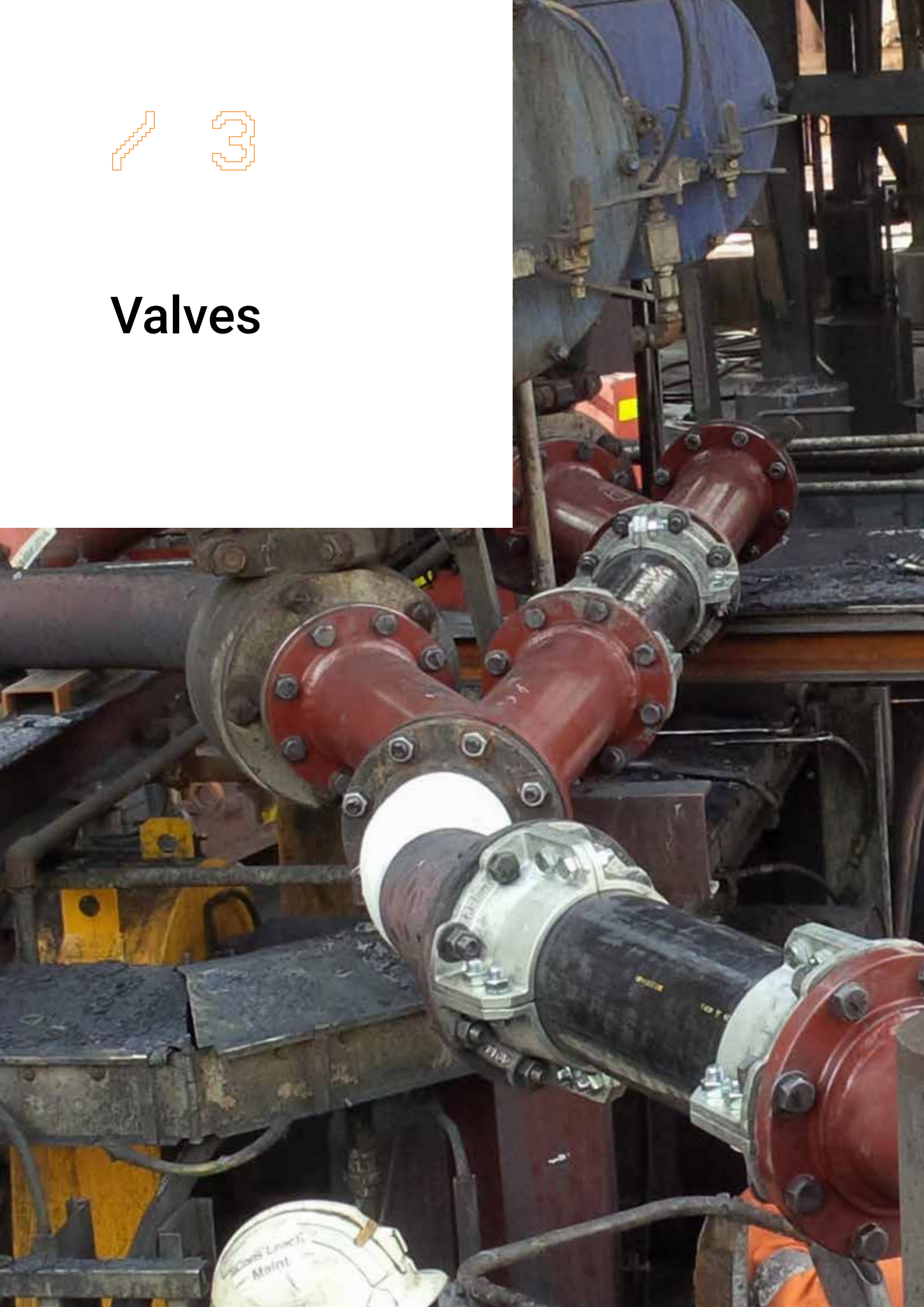



## Index

---

Butterfly Valve

# Butterfly Valve

**Note:** All Pexgol Fittings are compatible with ASA150 standard, fittings with flanges according to other flange standards can be supplied by special orders.

Butterfly valves are usually designed for straight metallic, with the diameter of the vane being defined as a function of the inner diameter of the pipe system under consideration. In some cases, the inner diameter of Pexgol pipes can be smaller than steel pipes. Thus, there might be interference between the wall thickness of a Pexgol pipe and the valve vane. The designer should consider this possibility early in the selection process for pipe systems and valves, and, if necessary, incorporate conical spacers between the flanges on the pipe and the valve.

**For example, connection between Pexgol pipe and a butterfly valve:**

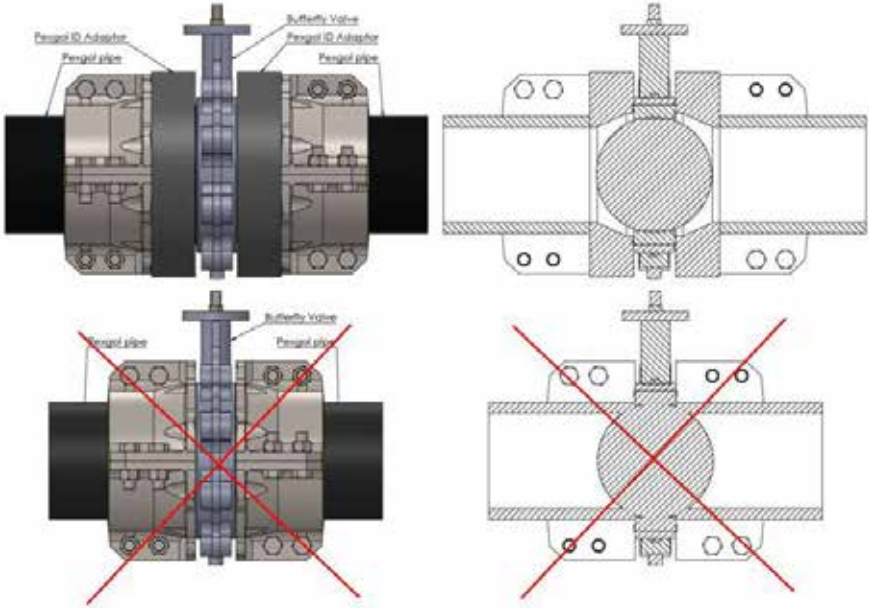





# Gaskets







## Index

---

Gaskets

# Gaskets

**Table 34.1: Gasket use recommendation in Pexgol pipe systems**



	Pexgol Flared End	GP Flanged Coupling	PE-X Lined Steel Fitting	Teflon Lined Steel Fitting	PE-Xc Fitting	Steel flange/Valve
Pexgol flared end	NO	NO	YES	YES	YES	NO
GP Flanged Coupling	NO	NO	NO	NO	NO	NO
PE-X Lined Steel Fitting	YES	NO	YES	YES	YES	YES
Teflon Lined Steel Fitting	YES	NO	YES	YES	YES	YES
PE-Xc Fitting	YES	NO	YES	YES	YES	YES
Steel Flange/ Valve	NO	NO	YES	YES	YES	YES

2023

The Principles of Systems Design



7 5

# Above Ground Installations





## Index

---

Above Ground Installations

Calculation of Forces at Fixpoints  
(due to thermal expansion/  
contraction)

Pexgol Horizontally Supported  
Pipeline

Natural Bending Radius

# Above Ground Installations

Above ground installation instructions for Pexgol pipes laid on the ground when the design temperature is lower than the installation temperature. The pipe tends to contract. The contraction creates axial stresses in the pipes which in severe cases could potentially cause pull out for some of the non-restrained fittings.

Installing Pexgol pipes above the ground with a calculated slack rather than in a straight line, is a way to reduce thermal stresses.

This procedure reduces the tendency of the pipe to pull out of its fittings.

The slack (calculated according to the Pexgol coefficient of thermal contraction) is 0.2% or 2 mm for every meter per 10°C.

The actual value depends on the temperature difference between the installation temperature and the lowest temperature.

The slack can be maintained by pushing the mid span of the pipe slightly sidewise during the installation. Axially unrestrained fittings should be secured and protected from pull out.

## Fixpoints

The fixpoint clamp is a standard item from Golan, fixpoint protect unrestrained fittings from pull-out. It is available for all pipe diameters from 63 mm. In addition, they are use to control thermal movement of the Pexgol pipe (eliminating contraction and expansion).

## Background

The following fittings are considered as unrestrained connections for above ground applications, and they require a pullout prevention technique:

- Flanged couplers
- Pexgol flared end connectors above 180 mm as mention in table 38.1
- Victaulic couplers
- Aquafast couplers

**Table 38.1: Flared-Ends that require fixpoints**

OD (mm)	Class						
	8	10	12	15	19	24	30
32						X	X
40				X	X	X	X
50				X	X	X	X
63				X	X	X	X
75	X	X	X	X	X	X	X
90	X	X	X	X	X	X	X
110	X	X	X	X			
125	X	X	X	X			
140	X	X	X	X			
160	X	X	X	X			
180	X	X	X	X			
200							
225							
250							
280							
315							
355							
400							
450							
500							
560							
630							
710							

Fixpoint is not required     
 Fixpoint is required

**Table 38.2: Other Fittings**

Fittings	Not Required
Bolt Connectors	X
GP Flange Couplers	
Mechanical double connectors up to class 24	X
Electrofusion Couplers	X
Reinforced Electrofusion Couplers series 1 and 2 up to 70°C	X
Reinforced Electr fusion Couplers series 2 above 70°C	
Victaulic Couplers	

For dewatering applications and inclined pipeline with slope over 40°, all Pexgol fittings are considered as unrestrained connections, and they require a pull-out prevention technique.

## Installation

Unrestrained fittings should be protected from pull-out by creating a fixpoint before and after each fitting using fixpoint clamps.

In some applications (like dewatering or inclined pipelines) it might be costly or problematic to install fixpoints in the line.

In that case, if you have of a non-restrained fitting which requires a pullout prevention device, it might be easier to replace the two fixpoints by a floating fixpoint device.

In cases of industrial installation over pipe supports, it is usually feasible to use the fixpoint clamps as pull-out prevention devices. However, in cases where the Pexgol pipe is connected to a steel pipe by a non-restrained fitting, it might be convenient to use the Fixpoint Bridge and install one clamp directly on the steel pipe. Alternatively, a combination of a back-flange and a fixpoint clamp can be used together with the existing steel.

### Installation instructions:

- Fixpoint clamps can be welded to horizontal and vertical support steelwork.
- Ensure this is done before installing the fixpoint clamps on the pipes.

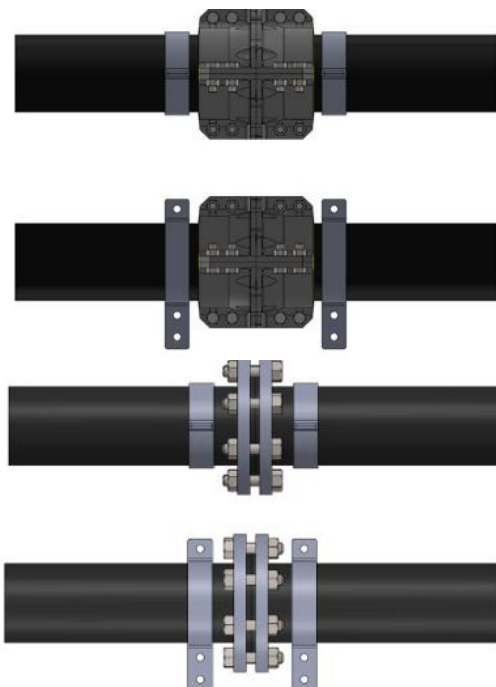

## Location

Fixpoints should be installed as close as possible to the unrestrained fittings to prevent the pipe from pulling out.

### Fixpoint Bridge

To ensure the pull-out resistance of certain fittings, do not lay the pipe perfectly straight, but rather with some surplus length (slack). In case of short pipes (up to about 10 meters), or in case of installations on pipe bridges (where it might be difficult to leave slack in the pipe), there should be a pull-out protection device such as a fixpoint clamp before and after every fitting.

For thermal stresses and forces on fixpoint, please check page 134 in the Engineering Guide.



# Calculation of Forces at Fixpoints (due to thermal expansion/contraction)

The axial forces transferred from the Pexgol pipe to the construction (through the fixpoint) are calculated by adding the values of the thermal stresses for the temperature range between Ti (Initial Temperature) until Tf (Final Temperature), and then multiplying that value by the cross section of the pipe.

$$F_{\text{thermal}} = \sigma_{\text{thermal}} \times \text{SRF} \times A$$

Where:

$\sigma_{\text{thermal}}$  - thermal stress

SRF - Stress Relaxation Factor for Pexgol piping = 0.7

A - Cross section of the pipe =

$$3.14 \times (D-t) \times t \text{ [mm]}$$

D - Outer Diameter (mm)

t - Wall thickness (mm)

**Table 40.1: Initial short term thermal stresses vs design temperature**

Design Temperature		Thermal stress [MPa]
Ti [C°]	Tf [C°]	
100	110	0.25
90	100	0.26
80	90	0.28
70	80	0.29
60	70	0.31
50	60	0.36
40	50	0.41
30	40	0.53
20	30	0.65
10	20	0.66
0	10	0.88
-10	0	1.01
-20	-10	1.30
-30	-20	1.61
-40	-30	2.72
-50	-40	1.11

For example, if we want to calculate the axial forces a 280 mm class 15 (SDR 11) Pexgol pipe exercises on the fixpoints when **heated** from 20°C to 60°C, then we look up our relevant range and sum the Thermal stress' values:

$$(0.65+0.53+0.41+0.36) = 1.95 \text{ MPa}$$

Wall thickness of such pipe is 25.4 mm so the area of the cross section of the pipe equals to:

$$3.14 \times 254.6 \times 25.4 = 20,306 \text{ mm}^2$$

Design Temperature		Thermal stress [MPa]
Ti [C°]	Tf [C°]	
50	60	0.36
40	50	0.41
30	40	0.53
20	30	0.65

The axial forces on the fixpoints are:

$$F_{\text{thermal (heating)}} = 1.95 \times 0.7 \times 20,306 = 27,717.7 \text{ N} = 2.77 \text{ Tons}$$

These Forces (due to thermal expansion/contraction) need to be taken as positive in case of heating (expansion) or alternatively as negative in case of cooling (contraction).

If the same pipe was to be **cooled** from 30°C to 10°C then we would add together the Thermal stress' values that are relevant to our case:

$$(0.65+0.66) = 1.31 \text{ MPa}$$

$$F_{\text{thermal (cooling)}} = 1.31 \times 0.7 \times 20,306 \times (-1)^* = -18,620.6 \text{ N} = -1.86 \text{ Tons}$$

Design Temperature		Thermal stress [MPa]
Ti [C°]	Tf [C°]	
20	30	0.65
10	20	0.66

\* The (-1) expresses the direction of the force that the pipe exercises on the fixpoint, and will correlate to the Bourdon Effect (influence of pressure) as follows.

## Calculation of additional Forces due to influence of internal Pressure:

$$F_{\text{pressure}} = (0.5-\nu) \times P \times (D/2t) \times A$$

Where:

$\nu$  - Poisson Ratio. The ratio at final temperature (Design Temperature).

Design Temperature	-50°C to 70°C	Above 70°C
Poisson Ration	0.4	0.5 (no effects from pressure)

P - Pressure (MPa)

A - Cross section of the pipe (mm<sup>2</sup>)

D - Outer Diameter (mm)

t - Wall thickness (mm)

$$F_{\text{total}} = F_{\text{thermal}} + F_{\text{pressure}} = \sigma_{\text{thermal}} \times \text{SRF} \times A + (0.5-\nu) \times P \times (D/2t) \times A$$



Now we can apply the effects of pressure to our previous calculations for 280 mm class 15 (SDR 11).

We will assume a pressure of 6 bar in the first case (heating) and 8 bar for the second (cooling):

- A.** Forces from thermal expansion at heating from 20°C to 60°C are 2.77 tons. We will add to this the forces that are transferred as consequence from pressure.  
 $F_{\text{pressure}} = (0.5 - \nu) \times P \times (D/2t) \times A = (0.5 - 0.4) \times 0.6 \times (280 / (2 \times 25.4)) \times 20306 = 6,769 \text{ N} = 0.68 \text{ Ton}$   
 **$F_{\text{total}} = 2.77 + 0.68 = 3.45 \text{ Ton}$**
- B.** Forces from thermal contraction at cooling from 30°C to 10°C are -1.86 tons. We will add to this the forces that are transferred as consequence from pressure.  
 $F_{\text{pressure}} = (0.5 - \nu) \times P \times (D/2t) \times A = (0.5 - 0.4) \times 0.8 \times (280 / (2 \times 25.4)) \times 20306 = 9,025 \text{ N} = 0.9 \text{ Ton}$   
 **$F_{\text{total}} = -1.86 + 0.9 = -0.96 \text{ Ton}$**

In the cooling scenario we can appreciate how the forces transferred to the fixpoint from the effect of pressure are in the opposite direction of those that came from thermal contraction, therefore easing the total force instead of adding to it (hence the importance of the negative sign expressing direction).

## Software

### Information relevant to the use of Force Calculation Software

Standard software stress analysis (such as CAESAR) works under the assumption that the pipe is operating within its limits of elasticity. This does not apply to plastic pipes.

Therefore, attempting to calculate the forces which the pipe transfers to the fixpoint clamps whilst using this sort of steel orientated software (that fail to consider the plastic behavior of the pipe), often returns values significantly higher than those obtained through the method described in the PPI - PE-X Manual (Plastic Pipe Institute).

The short-term Elastic Modulus and the Instantaneous Thermal Expansion Coefficient can both be found at PPI - PE-X Manual (Plastic Pipe Institute).

Poisson Ratio should be taken as follows:

Design Temperature	-50°C to 70°C	Above 70°C
Poisson Ratio	0.4	0.5

Mean Thermal Expansion Coefficient is detailed at Table (2.2):

T [°C]	Mean coefficient $\alpha$ [1/°C]
100°C	2.37E-04
90°C	2.14E-04
80°C	1.93E-04
70°C	1.75E-04
60°C	1.58E-04
50°C	1.46E-04
40°C	1.36E-04
30°C	1.24E-04
20°C	1.16E-04
10°C	1.04E-04
0°C	9.8E-05
-10°C	8.8E-05
-20°C	7.97E-05
-30°C	7.15E-05
-40°C	6.36E-05
-50°C	5.5E-05

### Maximum allowable stress as function of pipe temperature:

These values are based on DIN 16893 and the accumulated experience of Pexgol pipes in Infrastructure and Indus-

try applications.

The maximum allowable stresses in the table were calculated with a safety factor (SF) of 1.25 (which DIN 16893 designates for water).

A different SF may be considered in case of working with chemicals and corrosive agents (see chemical resistance tables in our Engineering Guide).

**Table 42.1: Changes of Design Stress Values  $\sigma$  with Temperature**

Temperature (°C)	$\sigma$ (kg/cm <sup>2</sup> )
10°C	85
20°C	76
30°C	66.5
40°C	59
50°C	52.5
60°C	48
70°C	42.5
80°C	37.5
90°C	33.5
95°C	32
100°C	27.5
105°C	22.5
110°C	18.75

**Note:** Some software's will apply specific safety factors as default. To avoid duplications, when calculating maximum allowable stress, make sure the SF is not already applied. Be sure to input an equivalent to our Stress Relaxation Factor of 0.7 to your simulation. This can be entered as Laying Conditions Factor or other.

# Pexgol Horizontally Supported Pipeline

The recommended distance between two adjacent supports for Pexgol pipes can be determine based on the following graph:  
(PPI, Chapter 8: Above Ground Applications for PE pipe)

**Table 43.1: Maximum supports distance**

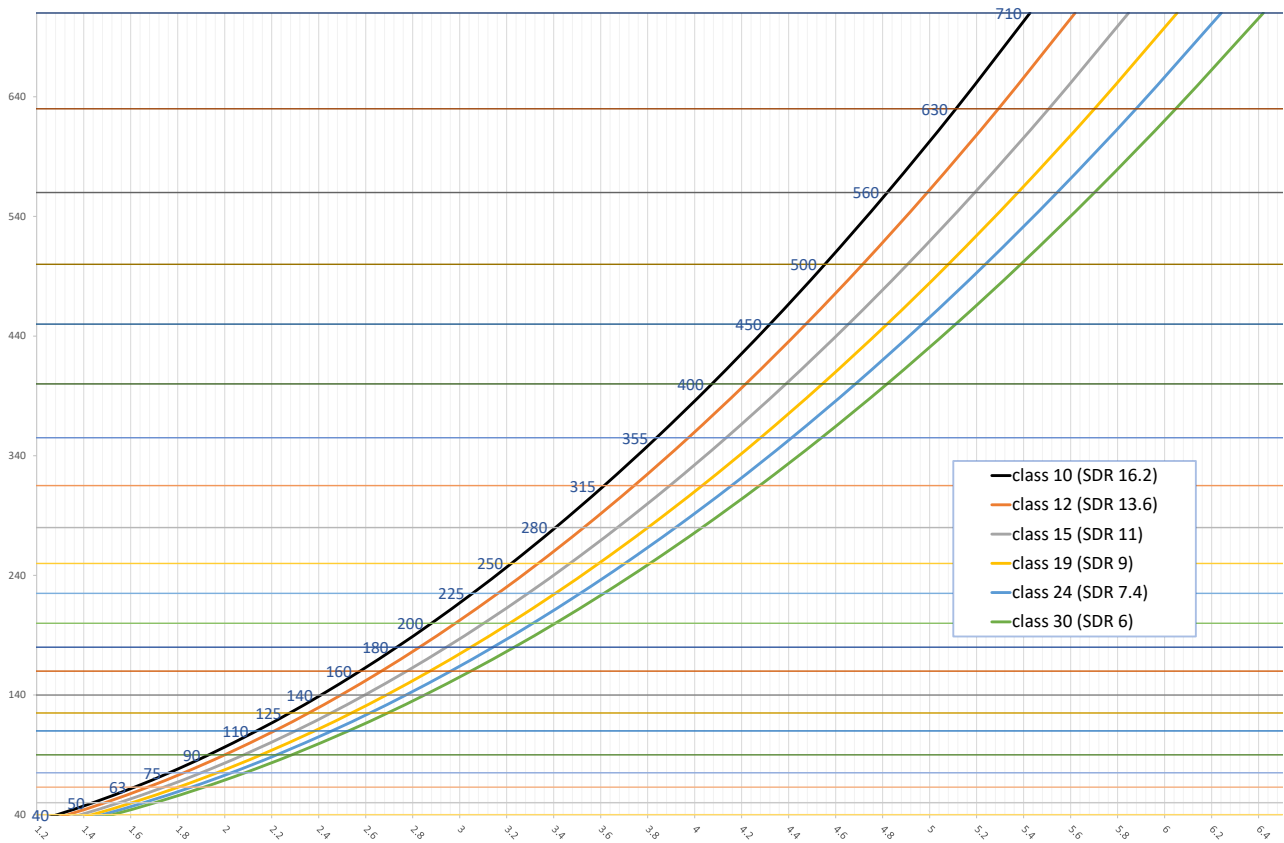

In the graph we calculated the Span length L for a Pexgol pipe transporting water at 20°C, with a permissible Deflection value of 0.5" ( in ) / 12.5 ( mm ).

In case of different design temperatures, or different fluid density, please check page 80 in the Engineering Guide.

## Types of Supports

Pexgol pipes have strong resistance to slow crack growth (SCG). This increased SCG resistance makes it possible to install Pexgol pipes on any surface or support.

# Natural Bending Radius

To create turns with Pexgol pipes laid inside trenches, above the ground or over pipe bridges, the pipe can be bent according to the following table.

**Table 44.1: Natural Bending Radius**

Pipe OD (mm)	Class 6	Class 8	Class 10	Class 12	Class 15	Class 19	Class 24	Class 30
110	13.5D	10.5D	8D	6.5D	5D	4.5D	3.5D	3D
125	16.5D	13.5D	10D	8.5D	6.5D	5.5D	4.5D	3.5D
140	16.5D	13.5D	10D	8.5D	6.5D	5.5D	4.5D	3.5D
160	16.5D	13.5D	10D	8.5D	6.5D	5.5D	4.5D	3.5D
180	16.5D	13.5D	10D	8.5D	6.5D	5.5D	4.5D	3.5D
200	16.5D	13.5D	10D	8.5D	6.5D	5.5D	4.5D	3.5D
225	16.5D	13.5D	10D	8.5D	6.5D	5.5D	4.5D	3.5D
250	20D	16D	12D	10D	8D	6.5D	5D	4D
280	20D	16D	12D	10D	8D	6.5D	5D	4D
315	27D	21.5D	16D	13.5D	11D	8.5D	7D	5.5D
355	27D	21.5D	16D	13.5D	11D	8.5D	7D	5.5D
400	34D	27D	20D	17D	13D	10.5D	8.5D	7D
450	34D	27D	20D	17D	13D	10.5D	8.5D	7D
500	40D	32D	24D	20D	16D	13D	10D	8D
560	43D	34.5D	26D	22D	17D	13.5D	11D	9D
630	47D	37D	28D	23.5D	19D	14.5D	12D	9.5D
710	50D	40D	30D	25D	20D	16D	13D	10D





# Installation

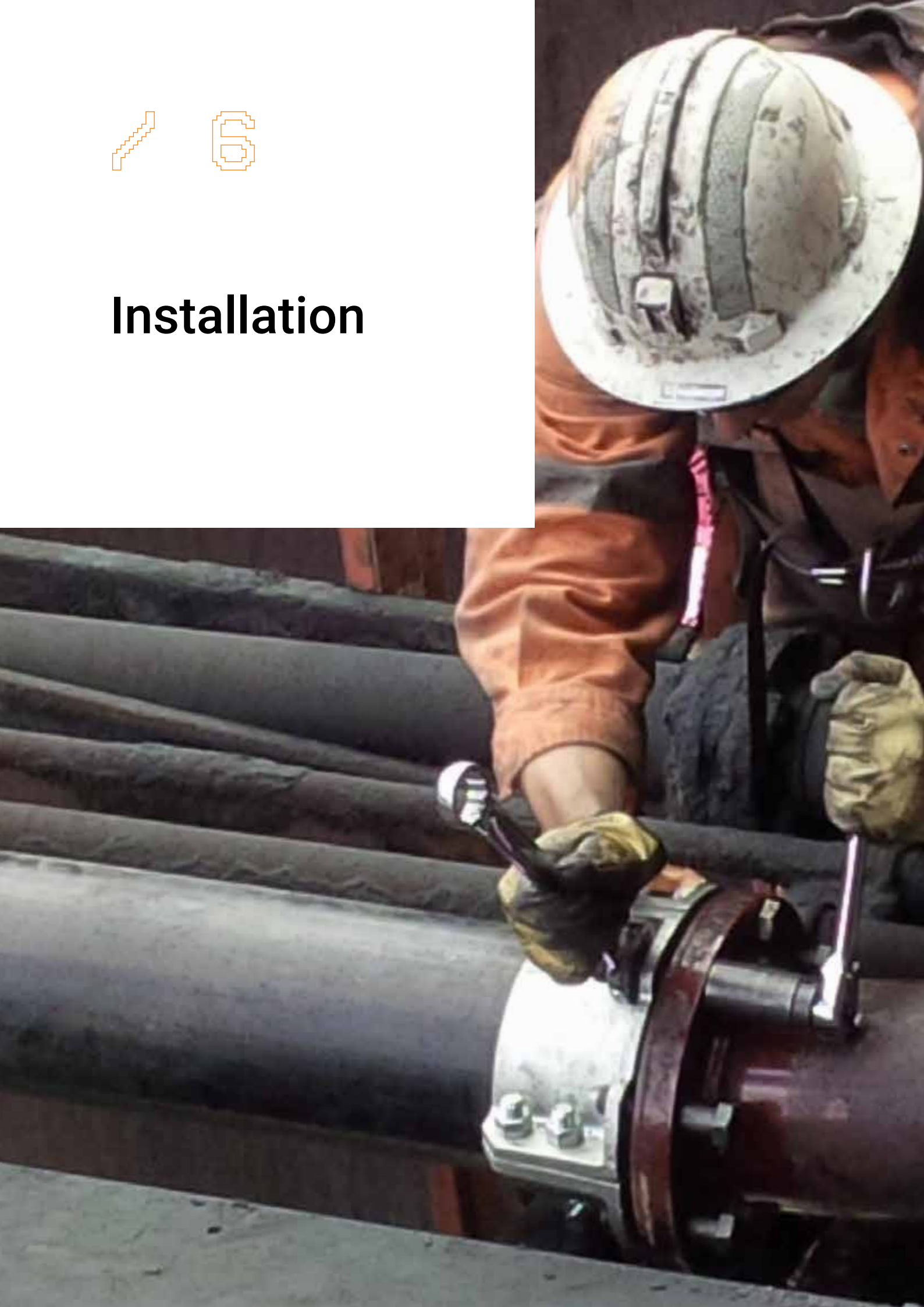



## Index

---

Installation Instructions for Coils

Delivery, Storage & Handling

# Installation Instructions for Coils

Minimum required time for settling the pipe on the ground (after removing it from the coil) prior to installation on a pipe rack:

- Up to 75 mm (including) there is no minimum time required and installation can begin immediately after opening the coils.
- From 90 mm and above, a 24 hour settling time is required after opening the coil and prior to installation.



# Delivery, Storage & Handling

## Packing, Shipping, Handling and Unloading

- Store material in it's original packaging and protect it from environmental damage.
- Take care not to scratch or gouge materials or otherwise create surface notches. Materials with notches more than 10% of the wall thickness shall be replaced, as per PPI requirement.
- Handle pipe, fittings, and valves in such manner as to prevent damage and / or contamination. Any material that become damaged shall be replaced with a new one.

## Storage and Protection

- Generally, store pipe, fittings, and materials in a temperature-controlled environment that should not exceed 50°C. Any special manufacturer's requirements should be followed.
- For Pexgol pipes, an outdoor laydown area should be arranged for storing the drums / coils with pipes. Prior to installation, pipe should be uncoiled from the drum/coil and left for stress relaxation. Required time for stress relaxation is 24 hours for pipes bigger than OD 75 mm. Pipes with 75 mm OD and below, can be installed immediately after opening the drums / coils.







**PEXGO**  
X-LINKED PIPING SOLUTIONS

**Disclaimer:**

- The Engineering guide contains technical information and recommendations for the selection of products for a specific application, installing and testing them.
- All our technical information consist of the most up to date information that we have regarding our products and solutions. As such, they are subject to constant assessment, modifications and updating .
- The technical information is presented on a Bona-Fida base, for assisting the end user to gain the maximum advantage from our products.
- When using any Technical information contained here, the end user should note that the Technical data are not binding. They neither constitute expressly warranted characteristics nor guaranteed properties nor a guaranteed Lifetime durability.



[www.pexgol.com](http://www.pexgol.com)

2023 © Copyright Pexgol

### Pexgol PE-Xa Pipes

Pexgol PE-Xa cross-linked polyethylene line pipe has many features that make it an excellent, cost-effective alternative to other pipe materials:

- Excellent chemical and corrosion resistance (chemical agents, slurries, toxic materials, radioactive materials).
- Reduced installation costs with long-length coils/spools.
- Improved flow capacity due to smooth interior surface.
- High resistance to abrasion and UV exposure.
- Wide working temperature range.



**Pexgol | Golan Plastic Products Ltd.**  
**Kibbutz Shaar HaGolan, 15145, Israel**

T. +972-77-9021040

F. +972-77-9021010

[contact@pexgol.com](mailto:contact@pexgol.com)

[www.pexgol.com](http://www.pexgol.com)



SCAN ME